

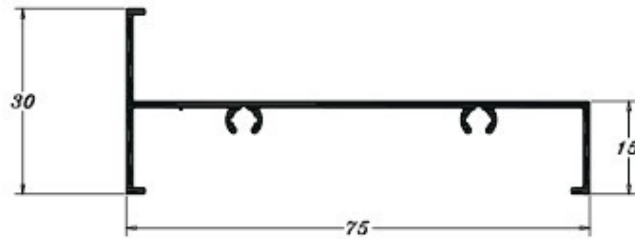

**PERMAX**  
EXTRUSÃO DE ALUMÍNIO

## LINHA 28



**PE 0544**  
0,383 Kg/m



**PE 0545**  
0,335 Kg/m

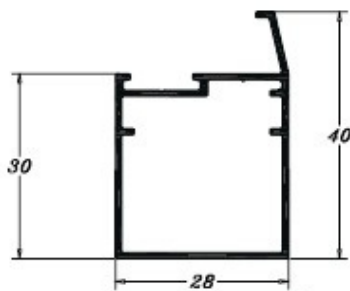

**PE 0546**  
0,371 Kg/m

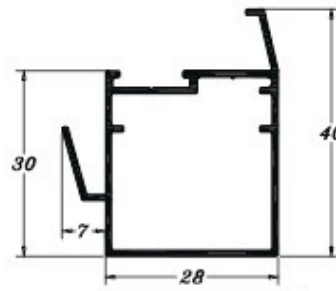

**PE 0547**  
0,412 Kg/m



**PERMAX**  
EXTRUSÃO DE ALUMÍNIO



**PERMAX**  
EXTRUSÃO DE ALUMÍNIO

## LINHA 28

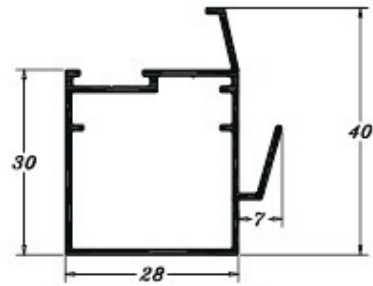

**PE 0548**  
0,412 Kg/m

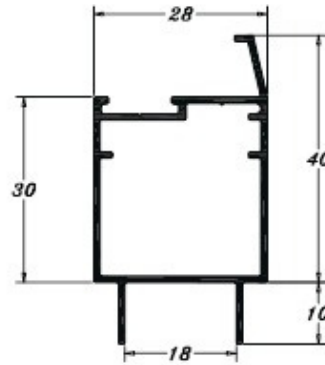

**PE 0549**  
0,425 Kg/m

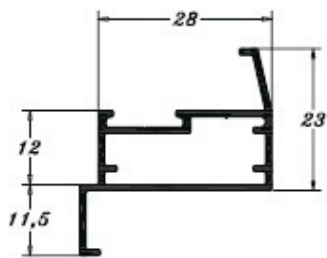

**PE 0550**  
0,331 Kg/m

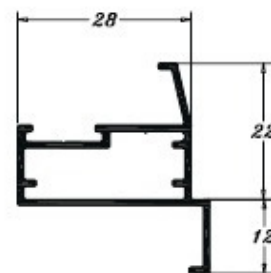

**PE 0551**  
0,323 Kg/m

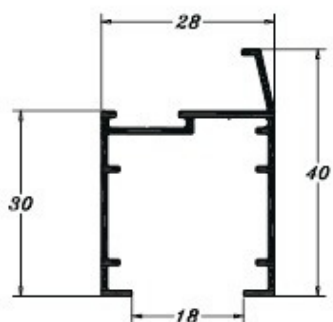

**PE 0552**  
0,333 Kg/m

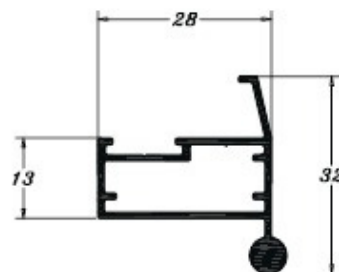

**PE 0553**  
0,363 Kg/m



**PERMAX**  
EXTRUSÃO DE ALUMÍNIO



**PERMAX**  
EXTRUSÃO DE ALUMÍNIO



## LINHA 28

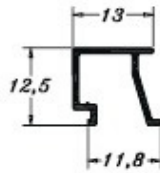

**PE 0554**  
0,100 Kg/m

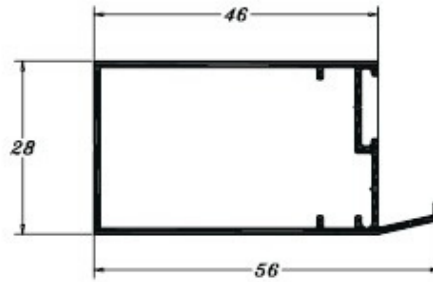

**PE 0555**  
0,457 Kg/m

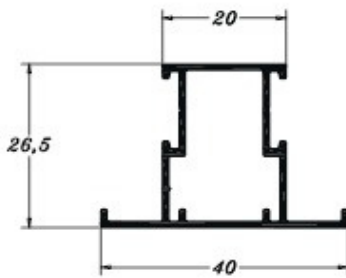

**PE 0556**  
0,351 Kg/m

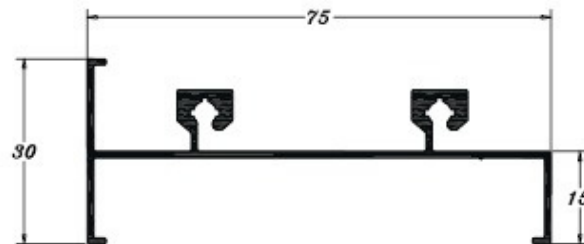

**PE 0557**  
0,574 Kg/m

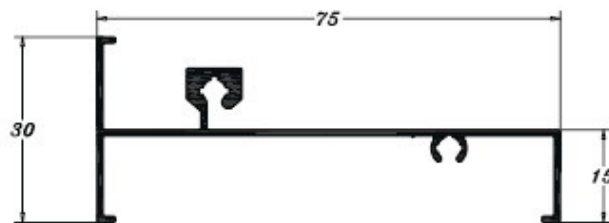

**PE 0558**  
0,478 Kg/m



**PERMAX**  
EXTRUSÃO DE ALUMÍNIO



**PERMAX**  
EXTRUSÃO DE ALUMÍNIO



## LINHA 28

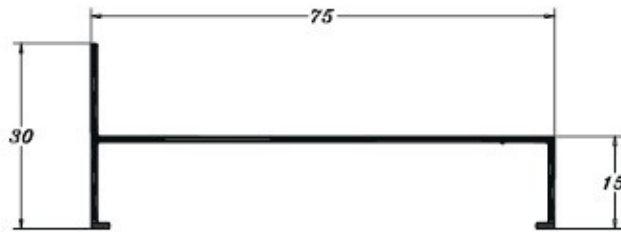

**PE 0559**

0,330 Kg/m



**PE 0560**

0,401 Kg/m

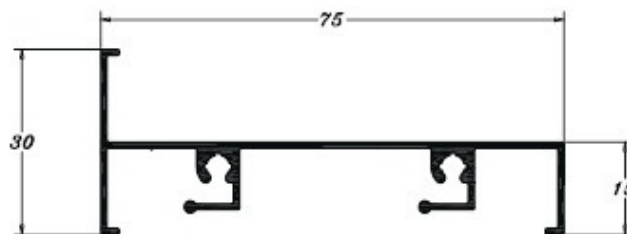

**PE 0561**

0,538 Kg/m

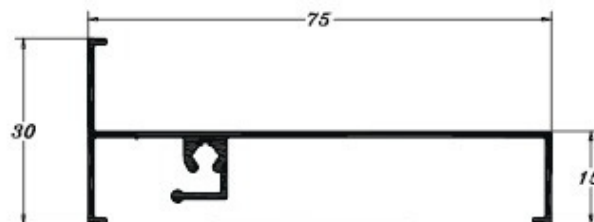

**PE 0562**

0,437 Kg/m



**PERMAX**  
EXTRUSÃO DE ALUMÍNIO



**PERMAX**  
EXTRUSÃO DE ALUMÍNIO

## LINHA 28

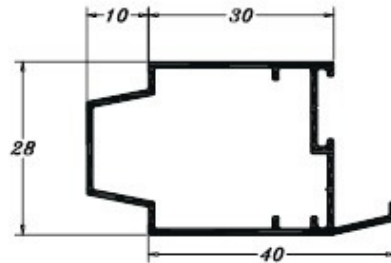

**PE 0563**  
0,415 Kg/m

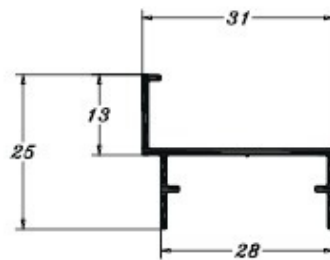

**PE 0564**  
0,197 Kg/m



**PERMAX**  
EXTRUSÃO DE ALUMÍNIO