

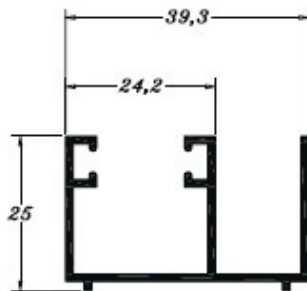

PERMAX
EXTRUSÃO DE ALUMÍNIO

BOX TEMPERADO 10 mm



E 306

0,418 Kg/m

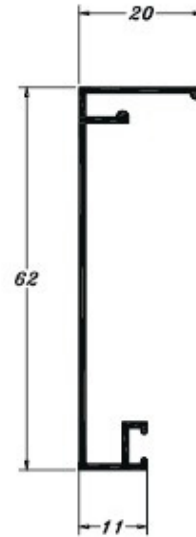

E 512

0,305 Kg/m

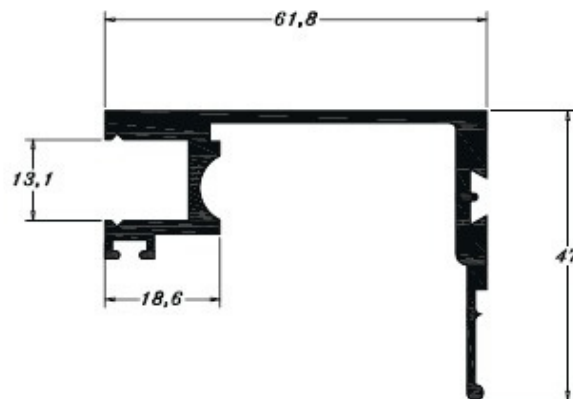

L 713

1,090 Kg/m



PERMAX
EXTRUSÃO DE ALUMÍNIO



PERMAX
EXTRUSÃO DE ALUMÍNIO

BOX TEMPERADO 10 mm

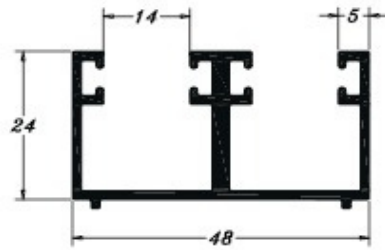

PE 0934

0,684 Kg/m

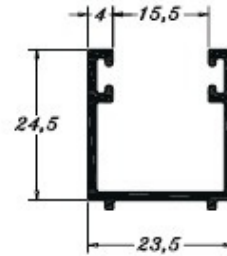

PE 0935

0,333 Kg/m

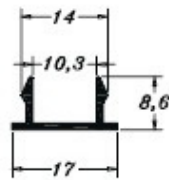

PE 0936

0,096 Kg/m

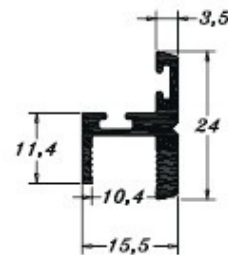

PE 0937

0,303 Kg/m

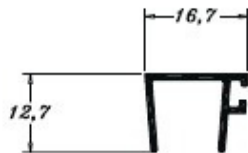

PE 0942

0,175 Kg/m

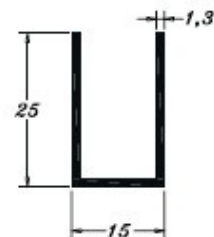

U555

0,220 Kg/m



PERMAX
EXTRUSÃO DE ALUMÍNIO