

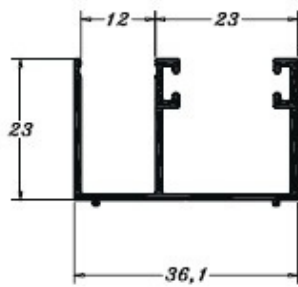

**PERMAX**  
EXTRUSÃO DE ALUMÍNIO

## TEMPERADOS



**PE0998**

0,356 Kg/m

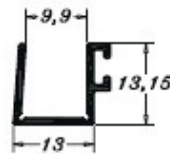

**PE0999**

0,130 Kg/m

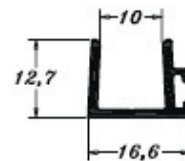

**PE1000**

0,159 Kg/m

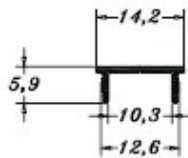

**PE1001**

0,062 Kg/m

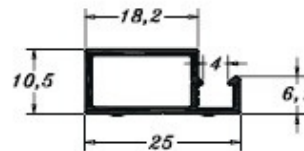

**PE1002**

0,182 Kg/m



**PE1003**

0,243 Kg/m



**PERMAX**  
EXTRUSÃO DE ALUMÍNIO



**PERMAX**  
EXTRUSÃO DE ALUMÍNIO

## TEMPERADOS

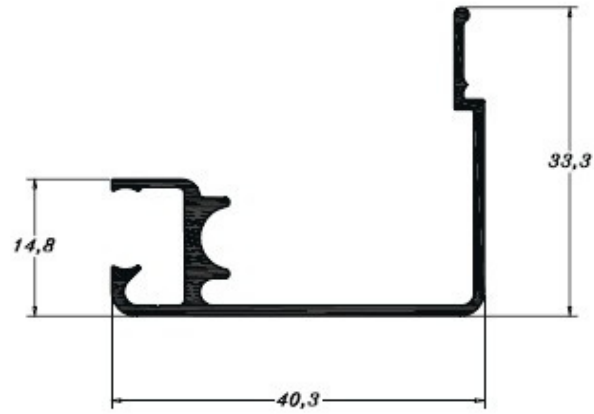

**PE1004**

0,797 Kg/m

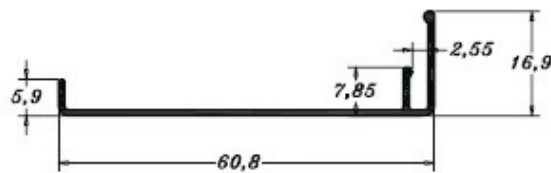

**PE1005**

0,240 Kg/m

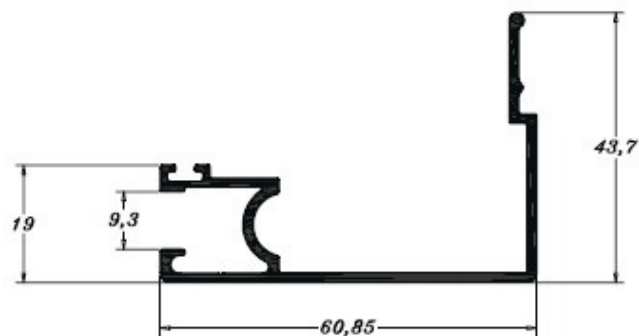

**PE1006**

0,631 Kg/m



**PERMAX**  
EXTRUSÃO DE ALUMÍNIO



**PERMAX**  
EXTRUSÃO DE ALUMÍNIO

## TEMPERADOS

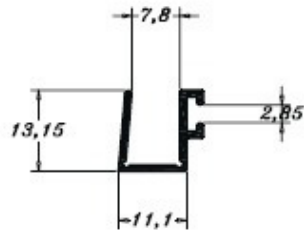

**PE1007**  
0,124 Kg/m

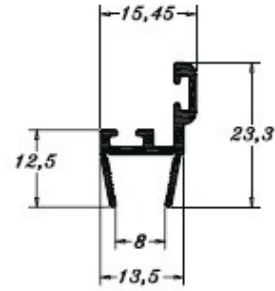

**PE1008**  
0,189 Kg/m



**PERMAX**  
EXTRUSÃO DE ALUMÍNIO